

**OMGA**<sup>®</sup>  
WOOD be nice.



V2013NC  
V235NC  
V235FNC

---

Double blade vertical mitre saws



## V2013 NC • V235 NC

# Automatic double blade vertical mitre saws



Model **V 2013 NC** has variable angle for square, hexagonal and octagonal frames.

Model **V 235 NC** is only suitable for square frames, being saw blades at a fix 90° angle.

A programmable numerical control with a 17" touch screen, allows the operator to follow operations step by step. USB and Ethernet ports are available for Input/Output and net connection.

The software also allows the reduction of waste by optimizing the length of the molding. A hopper feeder is available in various lengths for loading either vertical or horizontal.

Outfeed conveyor belts can complete the system either with only one kicker for downloading cut pieces, or with three kickers for length sorting and downloading.

The automatic cycle has not to be interrupted for loading new moldings.

# Automatic cutting systems for wood, plastic and aluminum profiles



## OPTIONS



Outfeed conveyor belt with kicker 1000 x 100 mm / 2000 x 100 mm



Length sorting conveyor belt 3000 x 100 mm with 3 kickers



Transfer conveyor belt with pneumatic feed step 2000 x 600 mm



Vertical hopper feeder for moldings 3000 / 4000 / 5000 / 6000 mm.



Horizontal hopper feeder with 2000 mm depth ramps for moldings 3000 / 4000 / 5000 / 6000 mm

## ADDITIONAL OPTIONS

Additional **2000 mm** ramp for horizontal hopper feeder.

Additional arm for vertical hopper feeder.

Additional kit for cutting aluminum profiles.

Increased feed length **1800 mm** (only for V 2013 NC)



## V235 • V235 FNC Vertical double blade mitre saws



**V235**, Vertical double blade mitre saw with 90° fix angle for cutting wood, plastic and aluminum.  
Two vertical clamps integrated with the cutting cycle.  
The sectioned fingers automatically adapt to any profile; no need for any adjustment. The double clamping action (top and sideways) ensures a perfect hold during cutting.  
The diagrammed table allows a direct measuring and a pneumatic

length stop guarantees the precise cut repeating.  
Manual length stops as well as diagrammed table extensions are available on request.  
The machine is also available in CE version.  
Model **V 235 FNC** is equipped with an electronic programmable length stop with storing capacity up to 400 lengths. Input is also possible through a Bar Code reader.



**V235**



**V235 FNC**



Bidirectional wafer clamps



RHS scaled table extension 1000 mm (only for V 235)



Set of front clamps (RHS + LHS)



Set of two dust collecting units.  
Dust chute 80 mm.  
Air speed 20 m/sec.  
Air volume 320 cu.m. each unit



Label printer







Bar Code reader (only for V 235 FNC)

OTHER OPTIONS

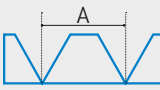
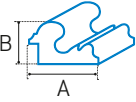
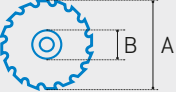
Higher fence

Saw blade lubrication spray system



		V2013NC	V235NC	V235	V235FNC
	mm	A = 1250 max	A = 1200 max	-	A = 2000 max (3000 optional)
	mm	A = 60 max B = 60 max	A = 90 max B = 70 max	A = 90 max B = 80 max	A = 90 max B = 80 max
	mm RPM	A = 300 B = 30 3000	A = 350 B = 30 3000	A = 350 B = 30 3000	A = 350 B = 30 3000
	kW	n° 2 x 2,2	n° 2 x 1,5	n° 2 x 1,5	n° 2 x 1,5 n° 1 x 1,0
	∅ mm	1 x 80 1 x 120	5 x 80	2 x 80	2 x 80
	bar NI/'	6 ÷ 7 485	6 ÷ 7 347	6 ÷ 7 188	6 ÷ 7 188
	Kg	1325 1733	970 1376	300 350	418 470
	L x W x H mm	2600x1850x1900 2730x580x1830	2750x1750x1900 2730x580x1830	883x1600x1700	883x1600x1700 500x3000x260



## V235NC

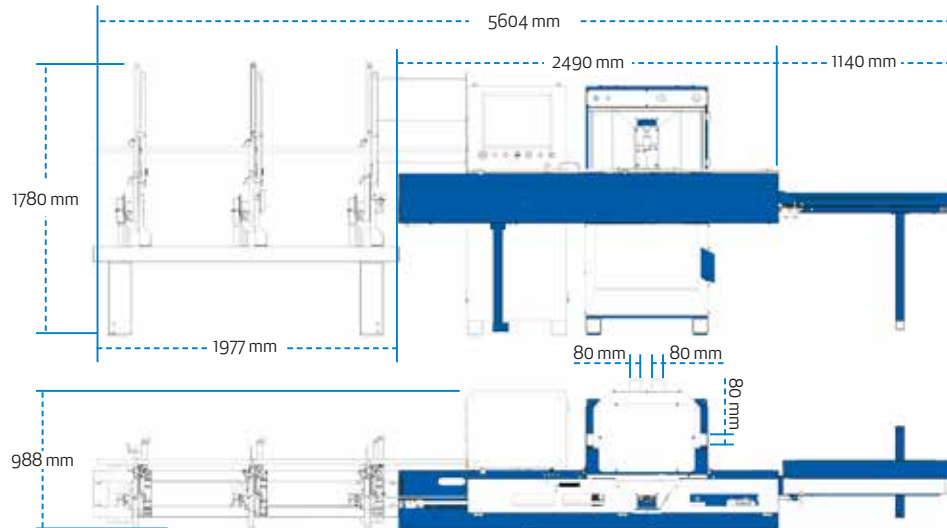

## V2013NC

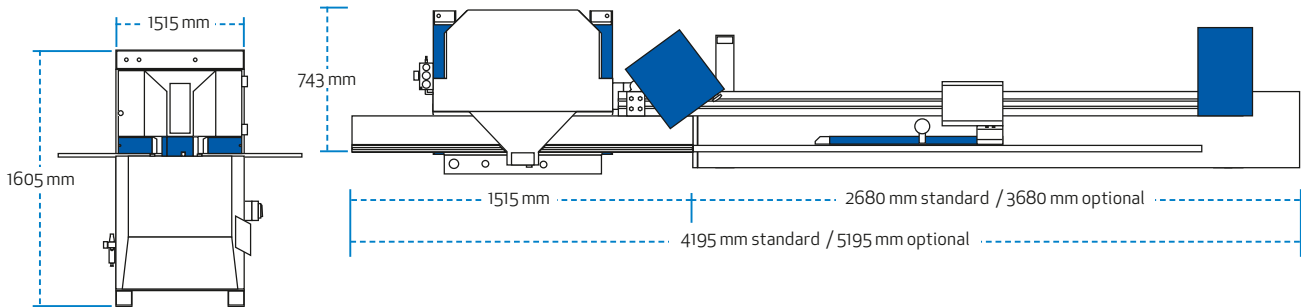
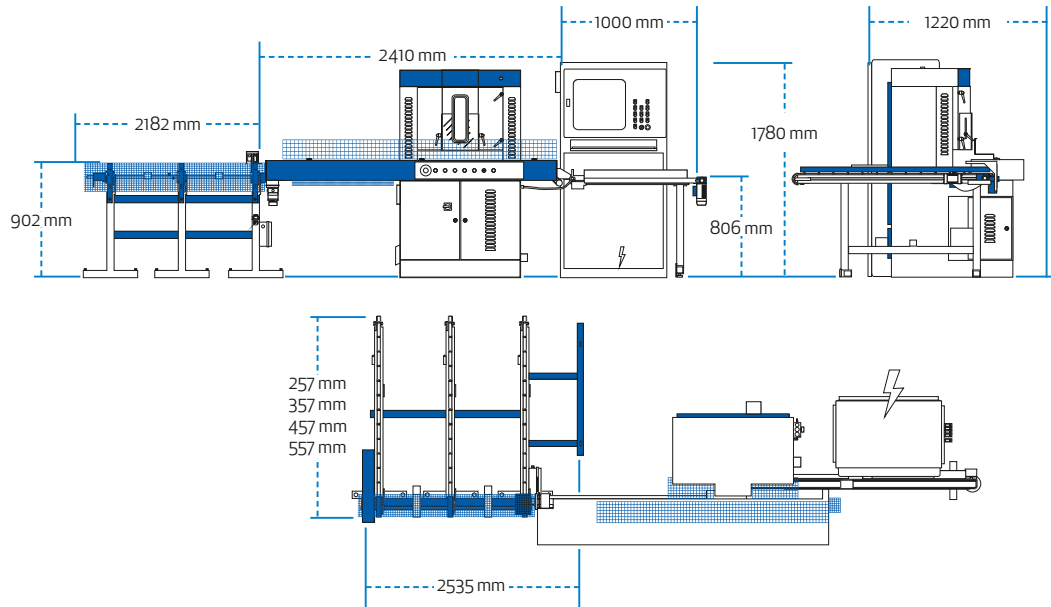

## V235

## V235FNC



**DIERREGI srl**  
Via della Scienza 5  
41012 Carpi (MO) - ITALY  
Tel. +39 059 803 0103  
Fax: +39 059 803 0113  
omga@omga.it  
**www.omga.it**